



EAN:	4013288105271	Size:	50x10x10 mm
Part number:	05160976001	Weight:	19 g
Article number:	899/4/1 S	Country of origin:	CZ
		Customs tariff number:	84661038

- Universal holder for the take-up of bits with 1/4" hexagon head drive
- Stainless sleeve, retaining ring and strong permanent magnet
- 1/4" hexagon drive (Wera connecting series 4)
- Strong retaining ring for optimum fit of the tool in the holder
- Strong permanent magnet holds the bits absolutely securely

Universal holder for the take-up of bits with 1/4" hex head drive as per DIN ISO 1173-C 6.3. Stainless sleeve for special corrosion protection. The particularly strong retaining ring ensures an optimum fixing of the tool in the holder. The especially strong permanent magnet makes sure that the bits are held absolutely securely. 1/4" hexagon, suitable for holders as per DIN ISO 1173-F 6.3.

Web link

<https://www.wera.de/en/05160976001>

Wera - 899/4/1 S
05160976001 - 4013288105271

Wera Werkzeuge GmbH
Korzter Straße 21-25
D-42349 Wuppertal
Tel: +49 (0)2 02 / 40 45-0
E-Mail: info@wera.de

Universal holder with stainless steel sleeve





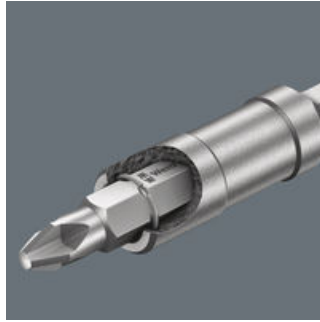

The retaining ring and the strong permanent magnet ensure a particularly secure fitting of the bit in the holder.

Universal Bit Holder with strong retaining ring



The retaining ring (S = extra strong) and the strong permanent magnet ensure a particularly secure fitting of the bit in the holder.

Further versions in this product family:

					
	inch	mm	inch	inch	mm
05160976001	1/4"	50	2"	1/4"	10.5
05160924001	1/4"	75	3"	1/4"	10.5
05160977001	1/4"	100	4"	1/4"	10.5
05160979001	1/4"	200	8"	1/4"	10.5
05160981001	1/4"	300	12"	1/4"	10.5

Web link

<https://www.wera.de/en/05160976001>

Wera - 899/4/1 S

05160976001 - 4013288105271

Wera Werkzeuge GmbH

Korzerter Straße 21-25

D-42349 Wuppertal

Tel: +49 (0)2 02 / 40 45-0

E-Mail: info@wera.de