

899/4/1 Universal Bit Holder, 1/4" x 100 mm

Universal Bit Holders with Stainless Steel Sleeve

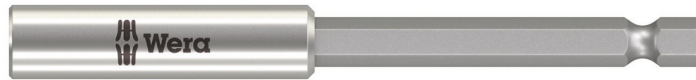

EAN:	4013288036711	Size:	100x11x11 mm
Part number:	05053459001	Weight:	39 g
Article number:	899/4/1	Country of origin:	CZ
		Customs tariff number:	84661038

- Universal holder for the take-up of bits with 1/4" hexagon head drive
- Stainless sleeve, retaining ring and strong permanent magnet
- 1/4" hexagon drive (Wera connecting series 4)

Universal holder for the take-up of bits with 1/4" hexagon head drive as per DIN ISO 1173-C 6.3. Stainless steel sleeve for very special corrosion protection. The retaining ring ensures an optimum fit of the tool in the holder. The strong permanent magnet holds the bits absolutely securely. 1/4" hexagonal, suitable for power screwdrivers with take-up as per DIN ISO 1173-F 6.3.

Web link

https://products.wera.de/en/bits_holders_adaptors_and_sets_holders_adaptors_connectors_universal_bit_holders_with_stainless_steel_sleeve_899_4_1.html

Wera - 899/4/1
05053459001 - 4013288036711

Wera Werkzeuge GmbH
Korzter Straße 21-25
D-42349 Wuppertal
Tel: +49 (0)2 02 / 40 45-0
E-Mail: info@wera.de





Universal Bit Holders with Stainless Steel Sleeve

Universal holder with stainless steel sleeve



The retaining ring and the strong permanent magnet ensure a particularly secure fitting of the bit in the holder.

Further versions in this product family:

	art no	 inch	 mm	 inch	 inch	 mm	
	05053457001	899/4/1 K	1/4"	50	2"	1/4"	10.5
	05053455001	899/4/1 75	1/4"	75	3"	1/4"	10.5
	05053459001	899/4/1 100	1/4"	100	4"	1/4"	10.5
	05053458001	899/4/1 152	1/4"	152	6"	1/4"	10.5

Web link

https://products.wera.de/en/bits_holders_adaptors_and_sets_holders_adaptors_connectors_universal_bit_holders_with_stainless_steel_sleeve_899_4_1.html

Wera - 899/4/1
05053459001 - 4013288036711

Wera Werkzeuge GmbH
Korzter Straße 21-25
D-42349 Wuppertal
Tel: +49 (0)2 02 / 40 45-0
E-Mail: info@wera.de