

# 1060 i VDE-insulated Kraftform slotted screwdriver, 0.4 x 2.5 x 80 mm

Kraftform 1000 VDE series



<b>EAN:</b>	4013288222268	<b>Size:</b>	161x25x25 mm
<b>Part number:</b>	05051580001	<b>Weight:</b>	25 g
<b>Article number:</b>	1060 i VDE	<b>Country of origin:</b>	CZ
		<b>Customs tariff number:</b>	82054000

- Insulated screwdriver for safe working up to 1,000 volts
- Individually tested
- Multi-component Kraftform handle for fast and low-fatigue working
- Handle markings simplify finding and sorting of tools
- The Wera Black Point tip offers an exact fit and optimum corrosion protection

Premium Kraftform VDE screwdriver. Multi-component Kraftform handle for fast and gentle work. The Wera Black Point tip and a sophisticated hardening process guarantee a long usability for the tip, increased corrosion protection and exact fitting accuracy. Individually tested at 10,000 V for safe working at the approved voltage of 1,000 V. The hexagon anti-roll protection avoids bits from rolling away annoyingly at the workplace. Handles marked for easy identification and sorting of tools.



VDE  
TOOL



BLACK  
POINT



KRAFTFORM  
ERGONOMICS



ANTI  
ROLL-OFF

## Web link

[https://products.wera.de/en/tools\\_by\\_trade\\_tools\\_for\\_electricians\\_kraftform\\_1000\\_vde\\_series\\_1060\\_i\\_vde.html](https://products.wera.de/en/tools_by_trade_tools_for_electricians_kraftform_1000_vde_series_1060_i_vde.html)

Wera - 1060 i VDE  
05051580001 - 4013288222268

Wera Werkzeuge GmbH  
Korzter Straße 21-25  
D-42349 Wuppertal  
Tel: +49 (0)2 02 / 40 45-0  
E-Mail: [info@wera.de](mailto:info@wera.de)

Kraftform 1000 VDE series

Individually tested



The individual testing at 10,000 volts, in accordance with IEC 60900, ensures safe working with loads up to 1,000 volts.

Ergonomic Kraftform handle



The multi-component Kraftform handle for quick and low-fatigue working.

Non-roll feature

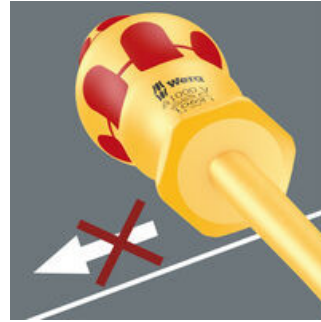

The hexagonal non-roll feature prevents any rolling away at the workplace.

Identification marking









The screw symbol and tip size identification markings on the handle make it easier to find the right screwdriver in the tool case, or at the workplace.

Wera Black Point tip



The Wera Black Point tip and a refined hardening process ensure long service life of the tip, improved corrosion protection and an exact fit.

Further versions in this product family:

	 mm	 mm	 mm	 mm	 inch	 inch
<b>05051580001</b>	<b>0.4</b>	<b>2.5</b>	<b>80</b>	<b>81</b>	<b>3/32"</b>	<b>3 1/8"</b>
05051582001	0.6	3.5	100	81	9/64"	4"
05051583001	0.8	4.0	100	98	5/32"	4"
05051587001	1.0	5.5	125	98	7/32"	5"

Web link

[https://products.wera.de/en/tools\\_by\\_trade\\_tools\\_for\\_electricians\\_kraftform\\_1000\\_vde\\_series\\_1060\\_i\\_vde.html](https://products.wera.de/en/tools_by_trade_tools_for_electricians_kraftform_1000_vde_series_1060_i_vde.html)

Wera - 1060 i VDE  
05051580001 - 401328822268

Wera Werkzeuge GmbH  
Korzter Straße 21-25  
D-42349 Wuppertal  
Tel: +49 (0)2 02 / 40 45-0  
E-Mail: info@wera.de