

6003 Joker Combination wrench, 5.5 x 105 mm

6003 Joker Combination wrench - Open end with return angle of just 15°. When things get tight.



| | | | |
|------------------------|---------------|-------------------------------|--------------|
| EAN: | 4013288219039 | Size: | 120x50x25 mm |
| Part number: | 05020190001 | Weight: | 37 g |
| Article number: | 6003 Joker | Country of origin: | CZ |
| | | Customs tariff number: | 82041100 |

- Especially suitable for tight spaces
- The special open end geometry expands the placement possibilities of the tool
- The low return angle in the open end "takes" the screw every 15°
- Slim ring side with 15° crank
- With Take it easy tool finder: colour coding by size

As installation spaces become increasingly confined, tools are necessary that enable users to work successfully even in such situations. Narrow spaces require additional placement points of the tool. Can spanners be modified so that the placement possibilities of the tool increase? The combination of the 7.5° offset open end and the double hexagon geometry doubles the placement points. A repeated 180° turn of the wrench around the longitudinal axis during screwdriving provides four placement possibilities, and bolts or screw heads can be engaged every 15°. The Joker 6003 with its smart open end geometry significantly expands the range of uses in confined spaces. The Joker 6003 will automatically find the respective placement point after every turn. The slim yet robust ring side is tilted by 15° to the tool axis. The high-quality surface treatment achieves a high and long-lasting corrosion protection. With tool finder "Take it easy": colour coding by size.

Web link

https://products.wera.de/en/joker_6003_joker_combination_wrench_open_end_with_return_angle_of_just_15_when_things_get_tight_6003_joker.html

Wera - 6003 Joker
05020190001 - 4013288219039

Wera Werkzeuge GmbH
Korzter Straße 21-25
D-42349 Wuppertal
Tel: +49 (0)2 02 / 40 45-0
E-Mail: info@wera.de

6003 Joker Combination wrench, 5.5 x 105 mm

6003 Joker Combination wrench - Open end with return angle of just 15°. When things get tight.

For very tight spaces



The Joker 6003 ring spanner with its special open end geometry - open end offset by 7.5° and the double hexagon profile - doubles the placement possibilities when repeatedly turning the wrench 180° around the longitudinal axis. Bolts and screw heads can be "accessed" every 15°. The Joker 6003 will automatically find the respective placement point after every turn.

Joker 6003: For return angles of less than 30°

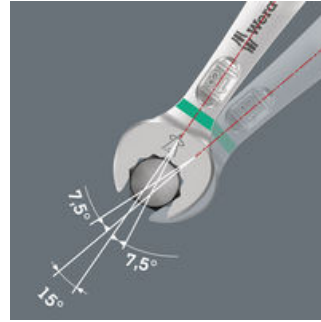

Thanks to the open end side offset by 7.5°, double hexagon geometry and an adjusted application method (placement - screwdriving - turning - replacement - screwdriving - turning, etc), even screwdriving challenges allowing a return angle of less than 30° can be solved.

Double-hex geometry

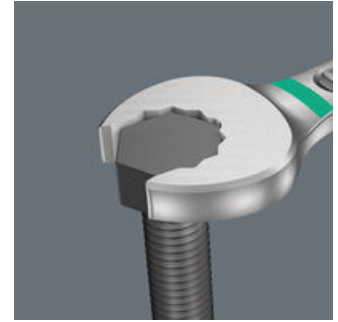

The double hexagon geometry on the open end and ring sides secures the positive connection with the screw head or bolt and reduces the risk of slipping.

Joker 6003: Tilted ring side

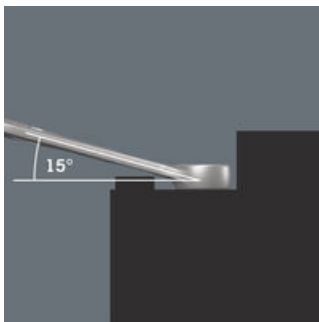

The ring side is tilted at 15° to the tool axis to prevent injury.

"Take it easy" tool finder



Take it easy tool finder system - with profile and size colour-coding for quick and easy tool selection. Colour-coded system for hexagon drive screws (L-Keys, Zyklus bit sockets), external hex drive screws and nuts (Joker wrenches, Zyklus sockets and Zyklus bit sockets with holding function), and TORX® drive screws (L-Keys, Zyklus bit sockets).

Web link

https://products.wera.de/en/joker_6003_joker_combination_wrench_open_end_with_return_angle_of_just_15_when_things_get_tight_6003_joker.html

Wera - 6003 Joker
05020190001 - 4013288219039

Wera Werkzeuge GmbH
Korzter Straße 21-25
D-42349 Wuppertal
Tel: +49 (0)2 02 / 40 45-0
E-Mail: info@wera.de

6003 Joker Combination wrench, 5.5 x 105 mm



6003 Joker Combination wrench - Open end with return angle of just 15°. When things get tight.

Further versions in this product family:



mm



mm



mm









mm



mm



mm

| | |  |  |  |  |  |  |
|--------------------|--------------------------|---|---|---|---|---|---|
| | | mm | mm | mm | mm | mm | mm |
| 05020190001 | leuchtorange_152C | 5.5 | 105 | 16 | 4 | 10 | 6 |
| 05020198001 | blau_307C | 6 | 105 | 16 | 4 | 10 | 6 |
| 05020199001 | gelb_123C | 7 | 110 | 17.7 | 4.2 | 11.5 | 6 |
| 05020200001 | leuchtpink_232C | 8 | 115 | 19 | 4.5 | 12.5 | 7 |
| 05020219001 | gruen_363C | 9 | 120 | 21 | 4.8 | 13.5 | 7 |
| 05020201001 | leuchtgelb_yello wC | 10 | 125 | 22 | 5 | 15 | 7 |
| 05020202001 | cyan_2985C | 11 | 135 | 24.5 | 5 | 17 | 8 |
| 05020203001 | schwarz_blackC | 12 | 148 | 26 | 5.5 | 18 | 8.5 |
| 05020204001 | tuerkis_339C | 13 | 160 | 27 | 6 | 19 | 8.5 |
| 05020205001 | pink_241C | 14 | 167 | 29 | 6 | 20 | 8.5 |
| 05020206001 | weiss | 15 | 174 | 32 | 6 | 22 | 8.5 |
| 05020207001 | violett_2735C | 16 | 182 | 35 | 6.5 | 23 | 10 |
| 05020208001 | rot_200C | 17 | 190 | 38 | 6.5 | 24.5 | 10 |
| 05020209001 | leuchtgruen_375C | 18 | 210 | 39 | 7.5 | 26 | 11.5 |
| 05020210001 | blau_307C | 19 | 230.0 | 42 | 7.5 | 27.5 | 11.5 |
| 05020500001 | leuchtpink_232C | 20 | 230.0 | 45 | 7.5 | 29 | 13 |
| 05020501001 | gruen_363C | 21 | 260 | 47 | 7.5 | 30 | 13 |
| 05020502001 | leuchtgelb_yello wC | 22 | 260 | 49 | 7.5 | 31.5 | 13 |
| 05020503001 | cyan_2985C | 24 | 280 | 53 | 8 | 36 | 14 |
| 05020504001 | schwarz_blackC | 27 | 300 | 60 | 8.5 | 40 | 14.5 |
| 05020505001 | tuerkis_339C | 30 | 330 | 66 | 9 | 43 | 16 |
| 05020506001 | pink_241C | 32 | 360 | 70 | 9.5 | 45.5 | 16.5 |
| 05020507001 | violett_2735C | 36 | 460 | 80 | 10 | 50.5 | 18 |

Web link

https://products.wera.de/en/joker_6003_joker_combination_wrench_open_end_with_return_angle_of_just_15_when_things_get_tight_6003_joker.html

Wera - 6003 Joker
05020190001 - 4013288219039

Wera Werkzeuge GmbH
Korzter Straße 21-25
D-42349 Wuppertal
Tel: +49 (0)2 02 / 40 45-0
E-Mail: info@wera.de